

Roll Number

TEST BOOKLET

180604

ENGLISH

Test Booklet No.

Test Booklet
Series

C

Name of the Candidate :

Signature of the Candidate :

Time : 2 Hours

Maximum Marks : 100

GENERAL INSTRUCTIONS FOR CANDIDATES

1. You are given a Test Booklet of 20 pages as well as Answer Sheet. Count the pages of the booklet and be sure that they are in proper order and the code number of the Test Booklet and Answer Sheet is the same. In case of a defective Test Booklet, report to your Invigilator and get it replaced.
2. Answers are to be indicated in the attached Answer Sheet.
3. Use English Numbers only to write on side-2 of the Answer Sheet.
4. Use **Blue/Black Ball Point Pen** only to write on Answer Sheet.
Use of pencil is strictly prohibited.
5. The booklet consists of 100 questions in **three** sections :
 - (i) Mental Ability Questions 1 – 50,
 - (ii) Arithmetic Questions 51 – 75 and
 - (iii) Language Questions 76 – 100.
6. All questions are to be attempted. Every question carries **one** mark.
7. Do not use white / correction fluid on Answer Sheet.
8. Overwriting, cutting and erasing on the Answer Sheet is not allowed. Do not make any stray mark on the Answer Sheet.
9. No changes in the answer once written is allowed.
10. You must attempt questions of each section because you have to qualify in each section separately.
11. Section (I) has **ten** parts. Separate directions are given for each part.
12. For every question, **four** probable answers bearing numbers 1, 2, 3 and 4 are given. Only one out of these is correct. After selecting the correct answer you should write the number in English in the box given against each question in the Answer Sheet. For example, answer 3 of question 37 is correct, you please write like this :

37

13. Rough work must not be done on the Answer Sheet. Use page number 20 of the Test Booklet for **rough work**.
14. A bell will be rung after every 30 minutes.

180604 C



(2)

SECTION - I

MENTAL ABILITY TEST

PART - I

Directions : In Question Nos. 1 to 5, there is a question figure on the left side and four answer figures marked 1, 2, 3, 4 are given on the right side. Select the answer figure which is exactly the mirror image of the question figure when the mirror is held at XY. Indicate your answer by number of the answer figure chosen by you in the box against the number corresponding to the question.

Question Figure

Answer Figures

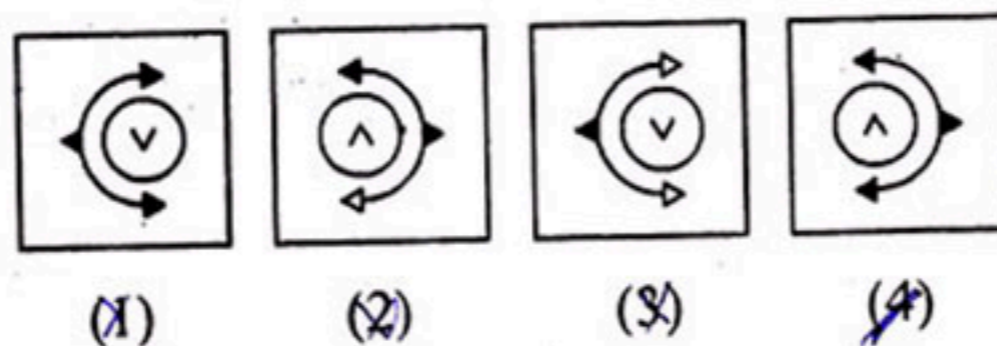
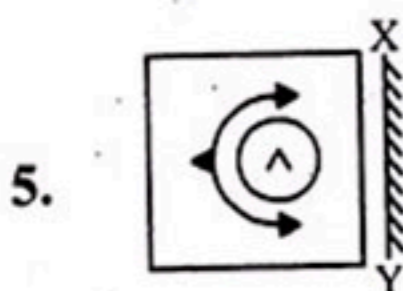
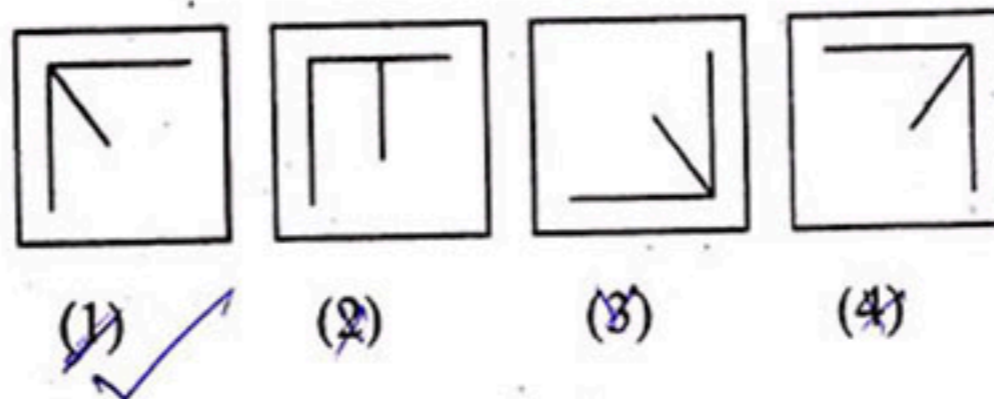
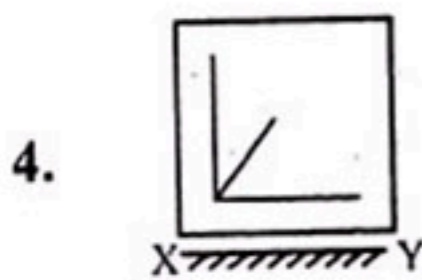
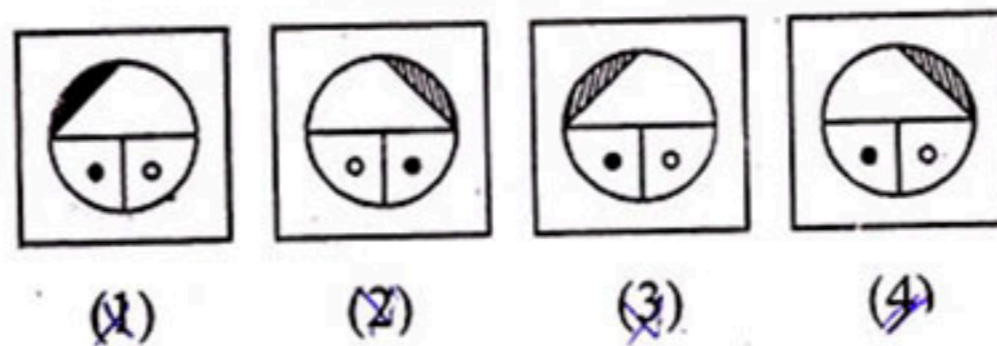
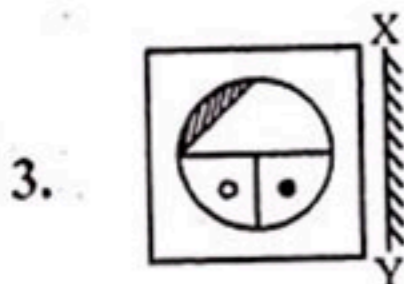
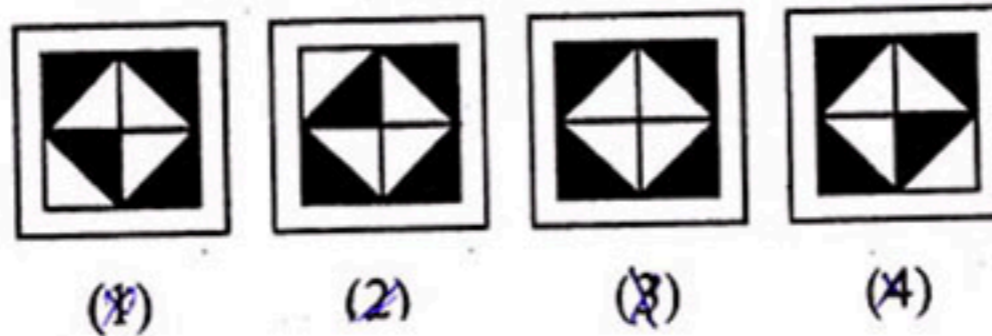
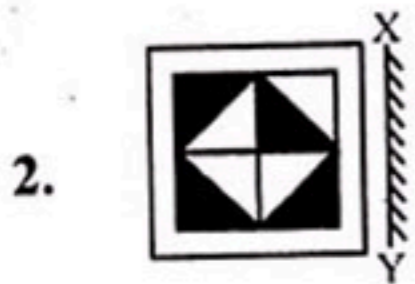
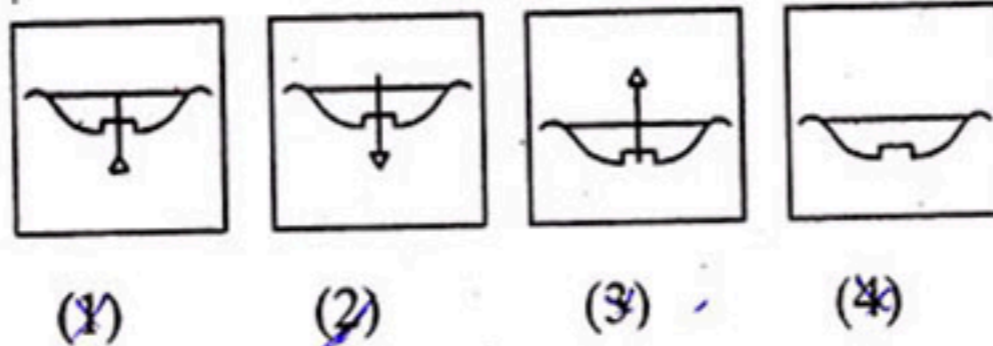
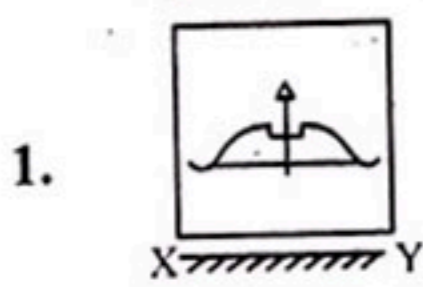

C

(3)

PART - II

Directions : In Question Nos. 6 to 10, a piece of paper is folded and punched as shown in question figures on the left side and four answer figures marked 1, 2, 3, 4 are given on right side. Select the answer figure which indicates how the paper will appear when opened (unfolded). Indicate your answer by number of the answer figure chosen by you in the box against the number corresponding to the question.

Question Figures

Answer Figures

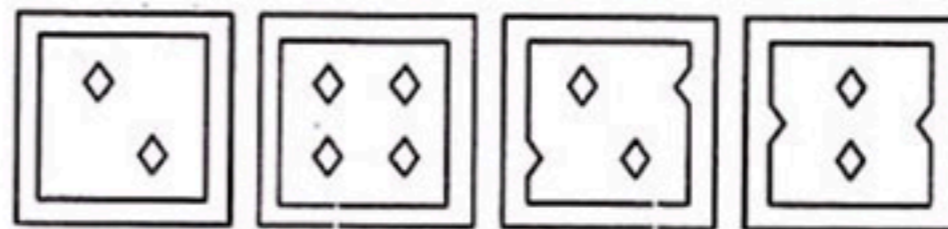
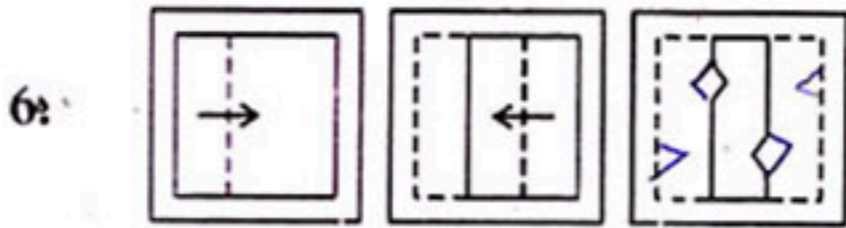

~~(1)~~ ~~(2)~~ ~~(3)~~ ~~(4)~~

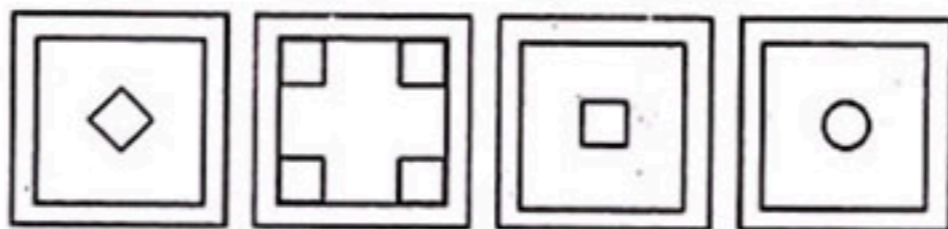
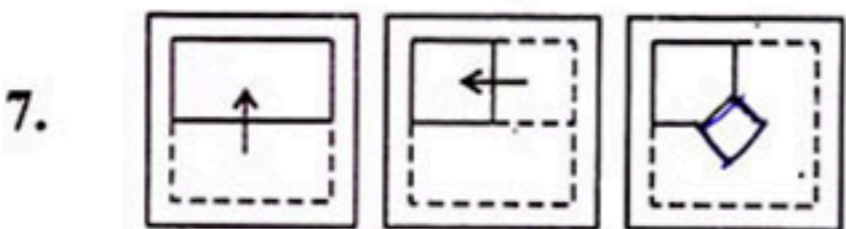

~~(1)~~ (2) (3) ~~(4)~~

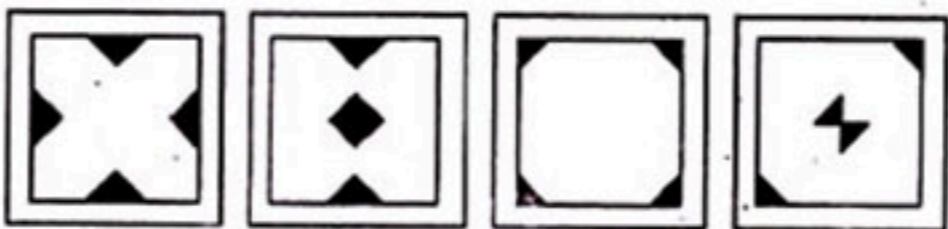
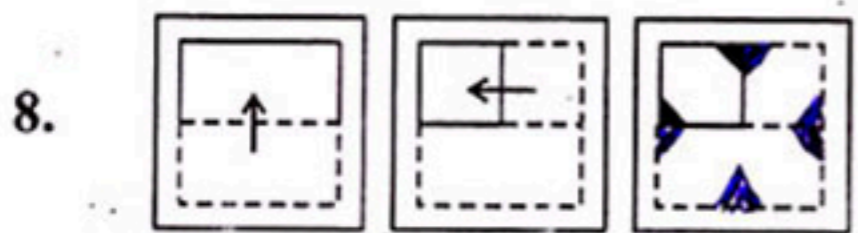

~~(1)~~ ~~(2)~~ ~~(3)~~ ~~(4)~~

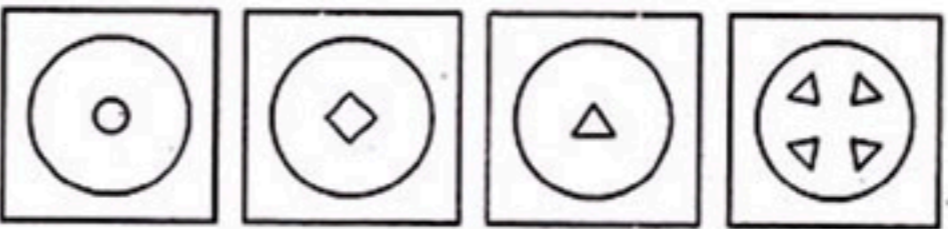
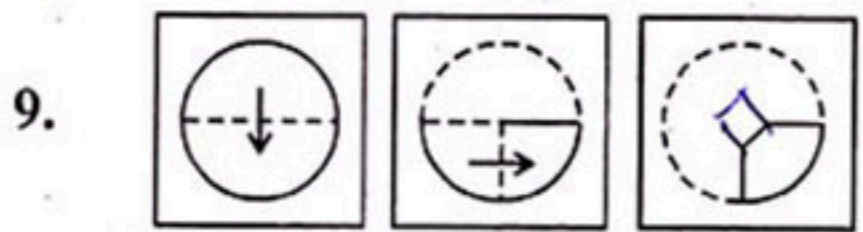

~~(1)~~ ~~(2)~~ ~~(3)~~ ~~(4)~~

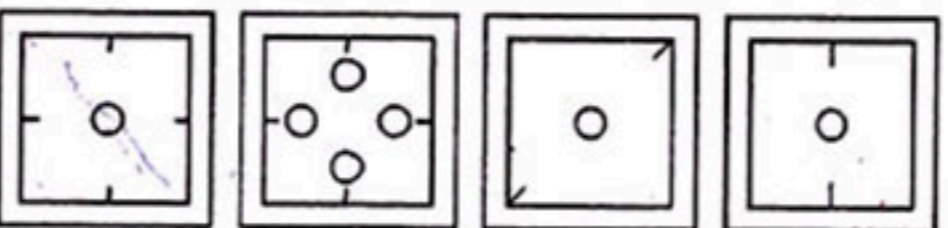
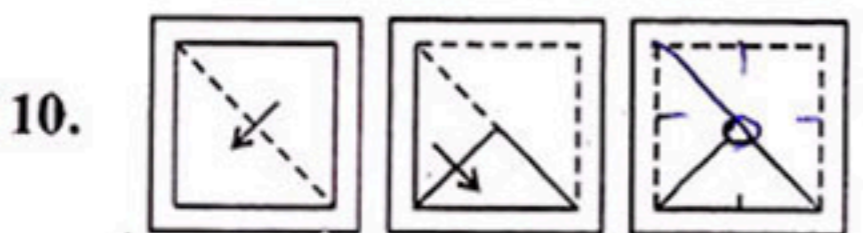

~~(1)~~ ~~(2)~~ ~~(3)~~ ~~(4)~~

PART - III

Directions : In Question Nos. 11 to 15, a question figure is given on the left side and four answer figures, marked 1, 2, 3, 4 are given on the right side. Select the answer figure which can be formed from the cut-out pieces given in the question figure and write your answer only in English numbers (i.e. 1, 2, 3, 4) in the box against the number corresponding to the question.

Question Figure

Answer Figures

11.

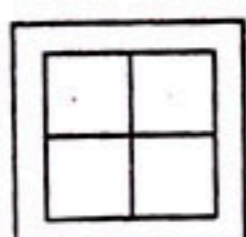
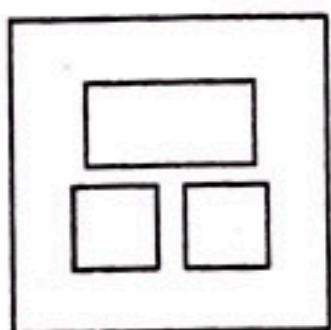
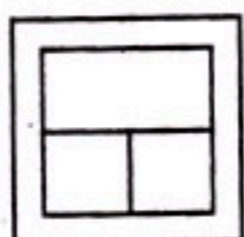
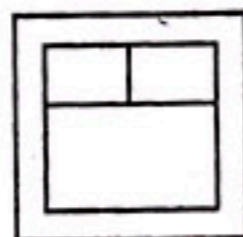
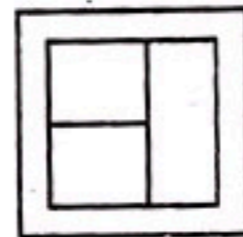
~~(1)~~~~(2)~~~~(3)~~~~(4)~~

12.

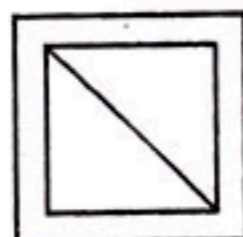
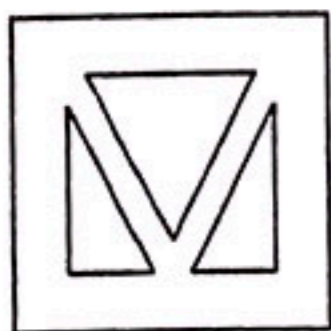
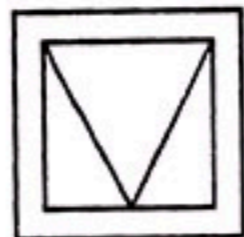
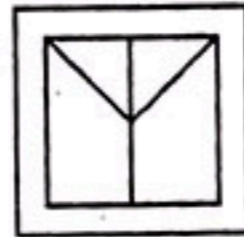
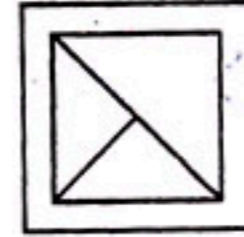
~~(1)~~~~(2)~~~~(3)~~~~(4)~~

13.

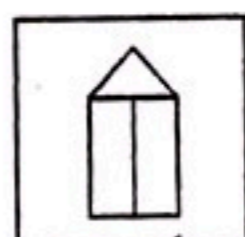
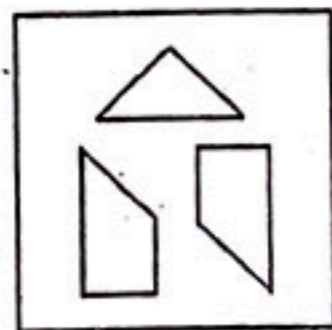
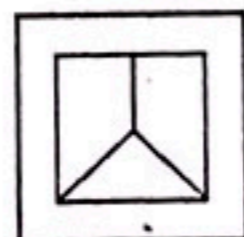
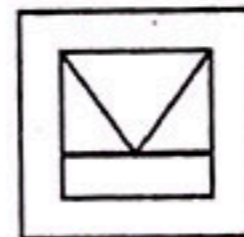
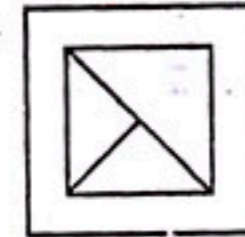
~~(1)~~~~(2)~~~~(3)~~~~(4)~~

14.

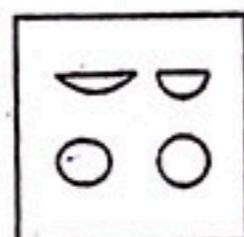
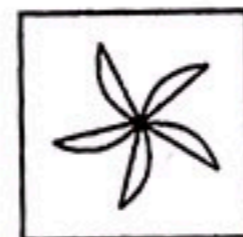
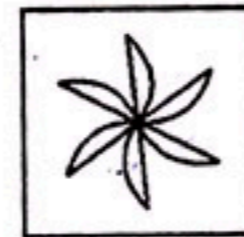
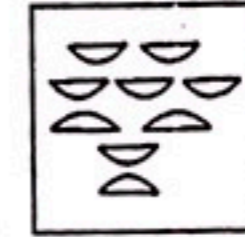



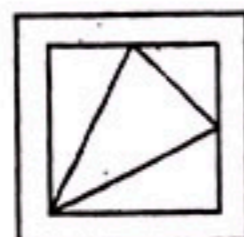
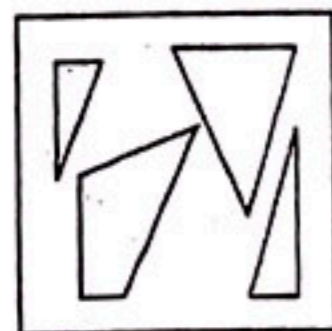
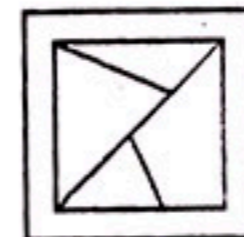
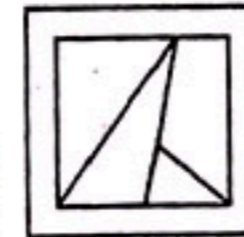
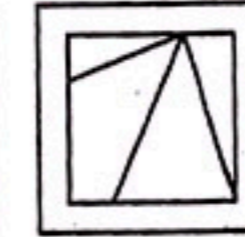

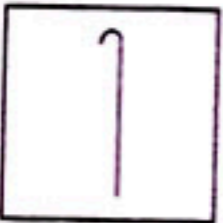

~~(1)~~~~(2)~~~~(3)~~~~(4)~~

15.

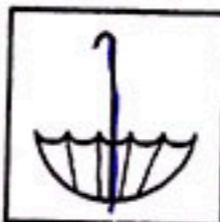
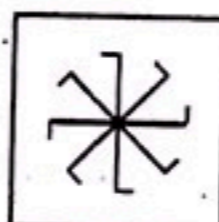
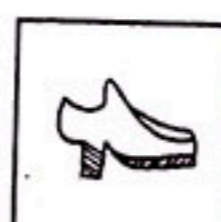
~~(1)~~~~(2)~~~~(3)~~~~(4)~~

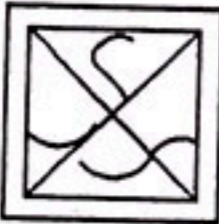
PART - IV

Directions : In Question Nos. 16 to 20, a question figure is given on the left side and four answer figures, marked 1, 2, 3, 4 are given on the right side. Select the answer figure which the question figure is hidden / embedded and write your answer only in English numbers (i.e. 1, 2, 3, 4) in the box against the number corresponding to the question.

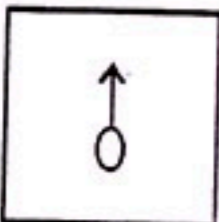
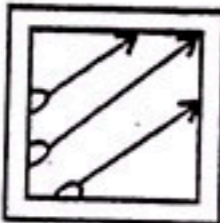
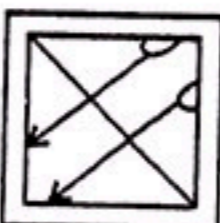
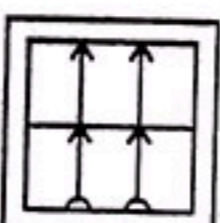
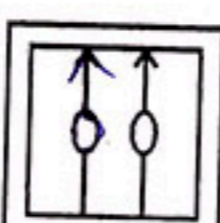
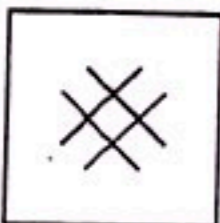
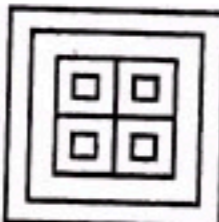
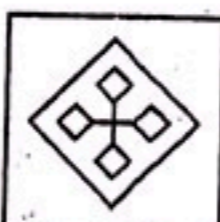
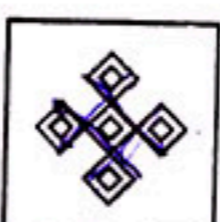
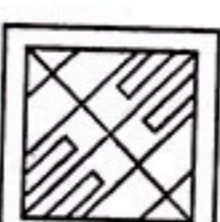
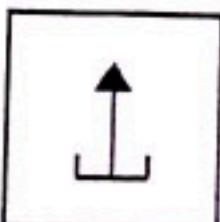
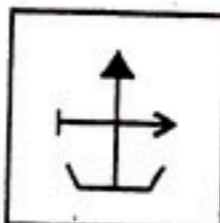
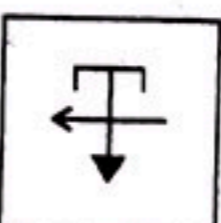
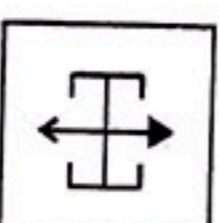
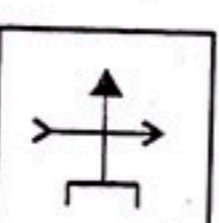
	Question Figure	Answer Figures			
16.					
		(1)	(2)	(3)	(4)
17.					
		(1)	(2)	(3)	(4)
18.					
		(1)	(2)	(3)	(4)
19.					
		(1)	(2)	(3)	(4)
20.					
		(1)	(2)	(3)	(4)

PART - V

Directions : In Question Nos. 21 to 25, four figures 1, 2, 3 and 4 have been given in each question. Of these four figures, three figures are similar in some way and one figure is different. Select the figure which is different and write your answer only in English numbers (i.e., 1, 2, 3, 4) in the box against the number corresponding to the question.

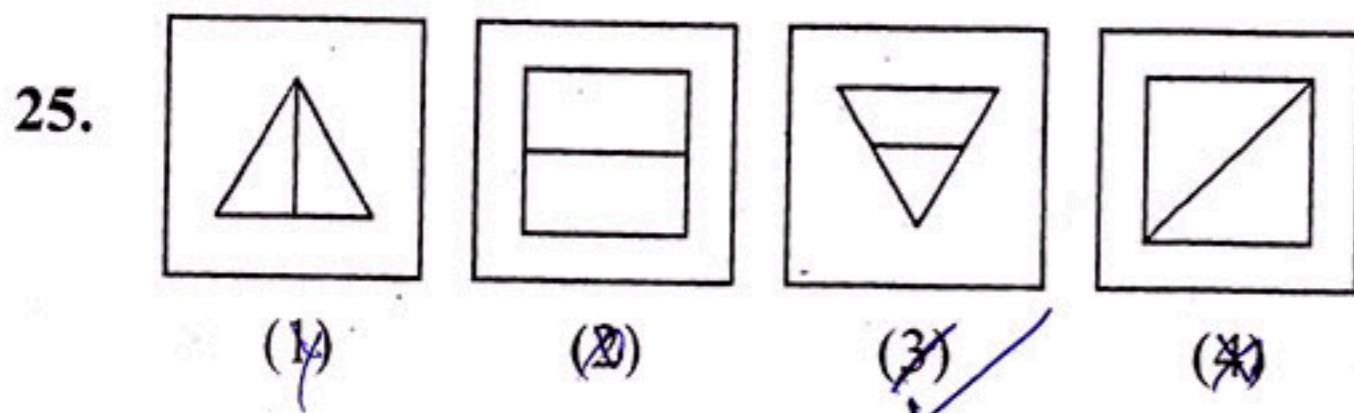
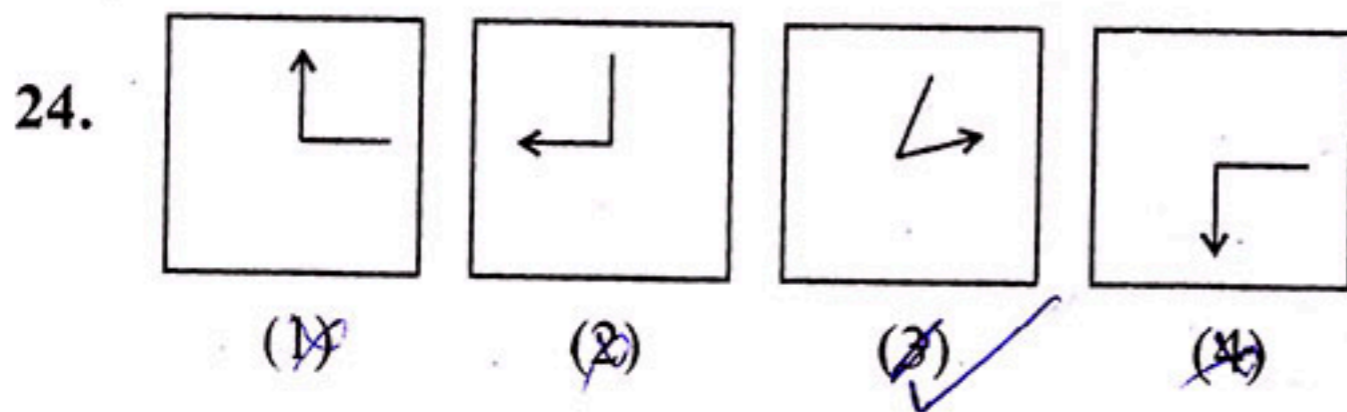
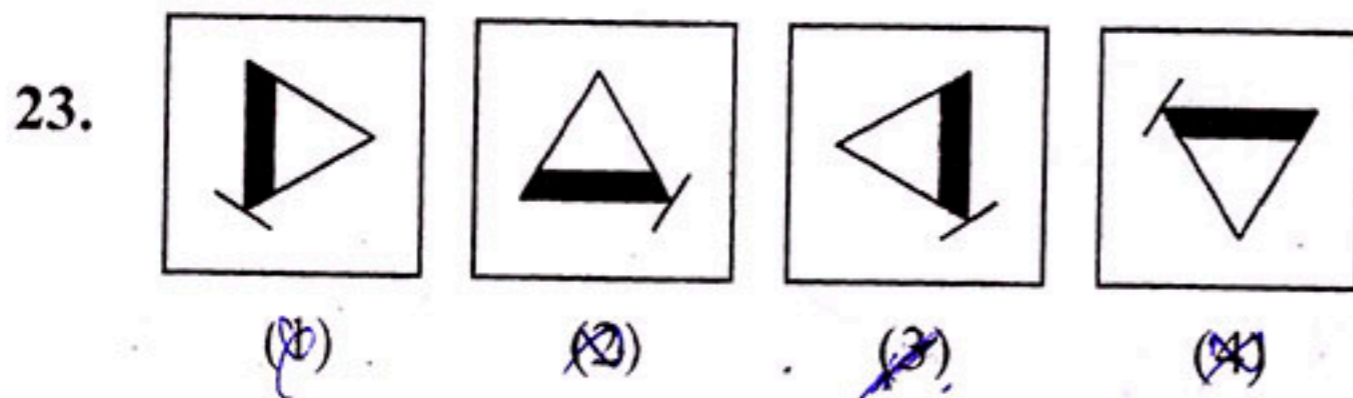
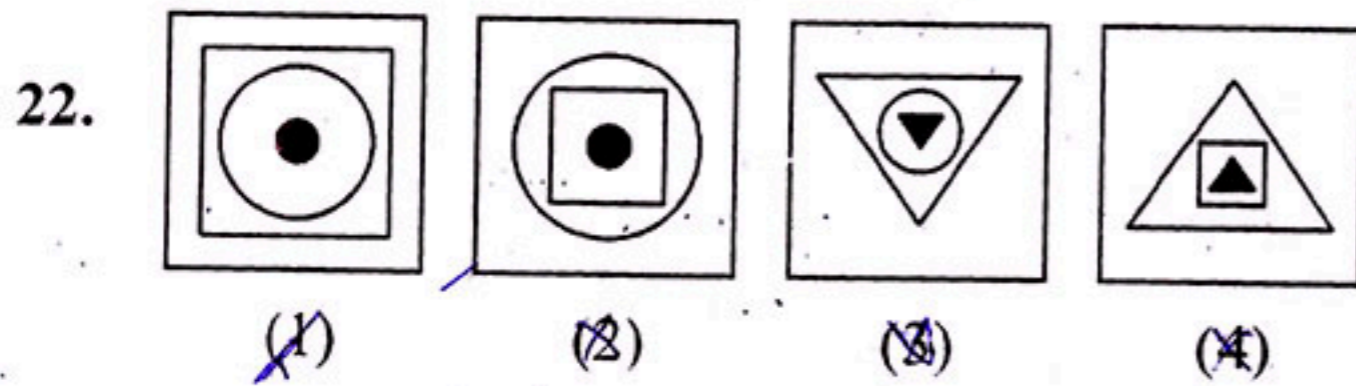
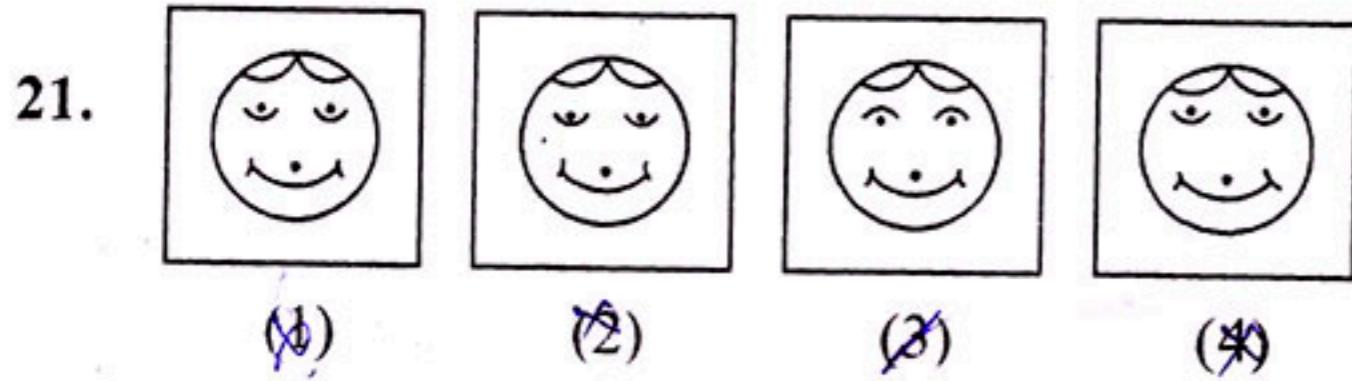

PART - VI

Directions : In Question Nos. 26 to 30, a question figure is given on the left side and four answer figures marked 1, 2, 3, 4 are given on the right side. Select the answer figure which is exactly the same as the question figure and write your answer only in English numbers (i.e. 1, 2, 3, 4) in the box against the number corresponding to the question.

Question Figure

Answer Figures

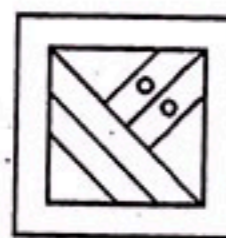
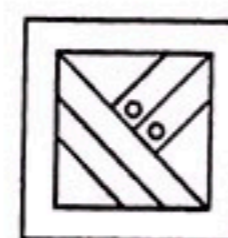
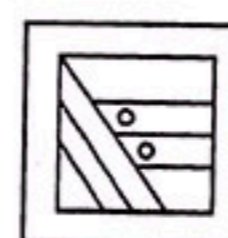
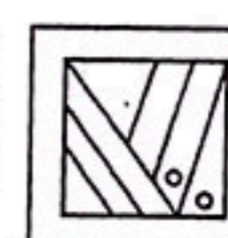
26.     

(1) (2) (3) (4)

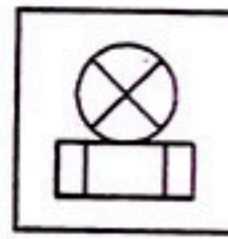
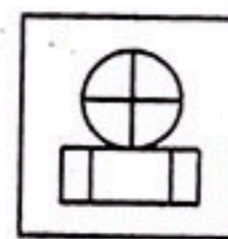
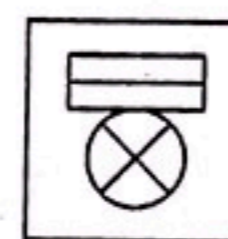
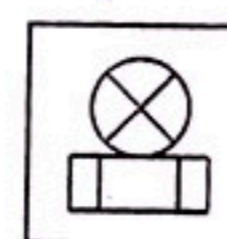
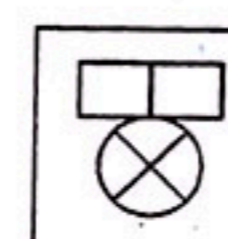
27.     

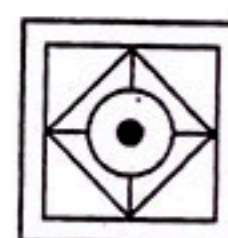
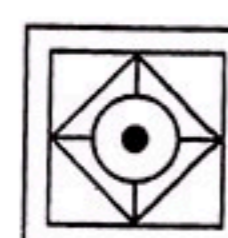
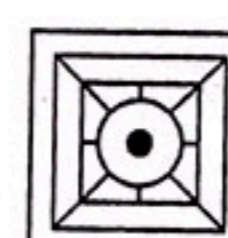
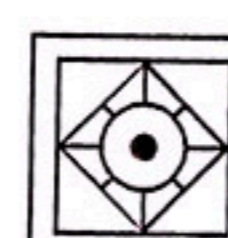
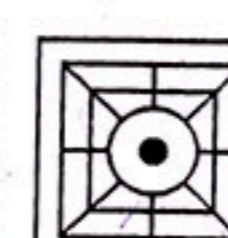

(1) (2) (3) (4)

28.     

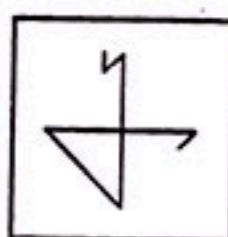
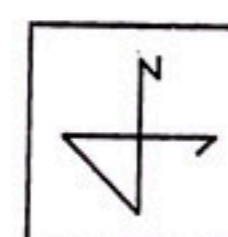
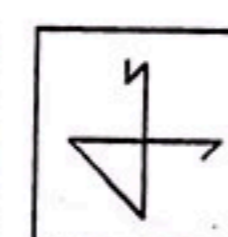
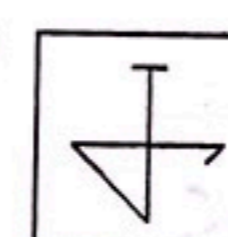
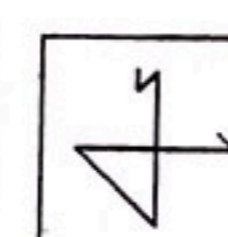
(1) (2) (3) (4)

29.     

(1) (2) (3) (4)

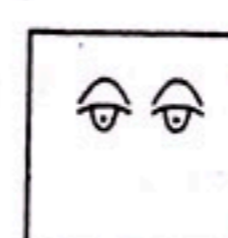
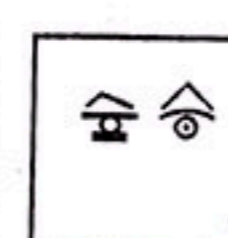
30.     

(1) (2) (3) (4)

PART - VII

Directions : In Question Nos. 31 to 35, there is a question figure on the left hand side, a part of which is missing. Observe the answer figures 1, 2, 3, 4 on the right hand side and find out the answer figure which without changing the direction, fits in the missing part of the question figure in order to complete the pattern in the question figure. Indicate your answer by number of the answer figure chosen by you in the box against the number corresponding to the question.

Question Figure

Answer Figures

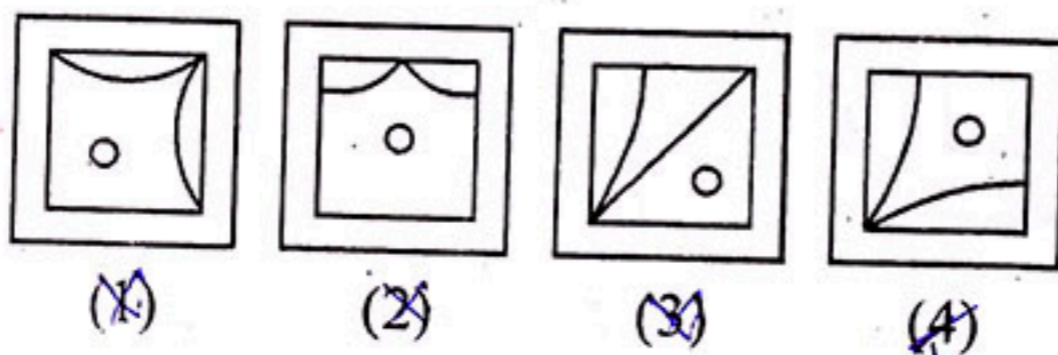
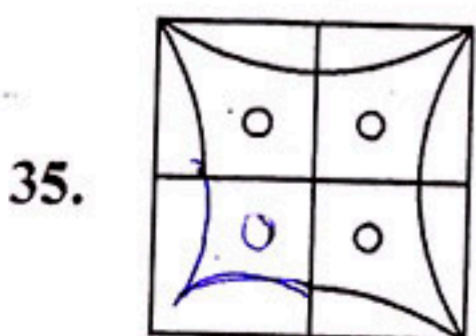
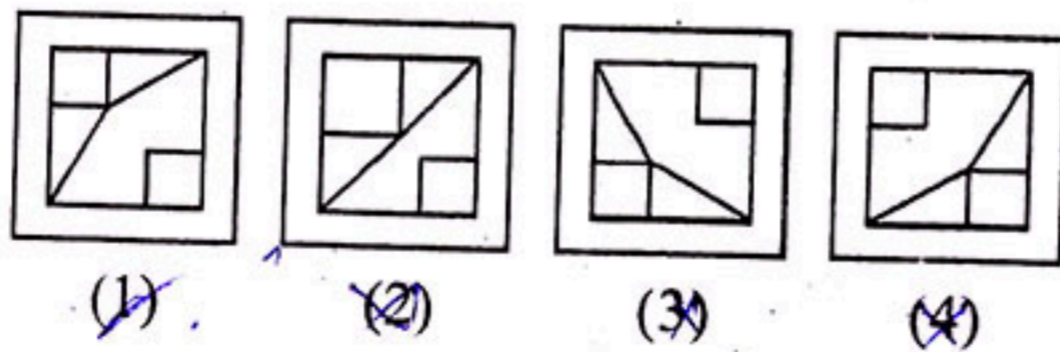
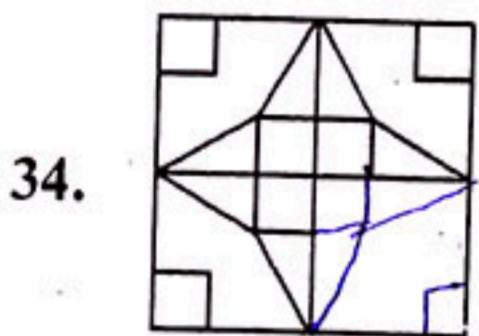
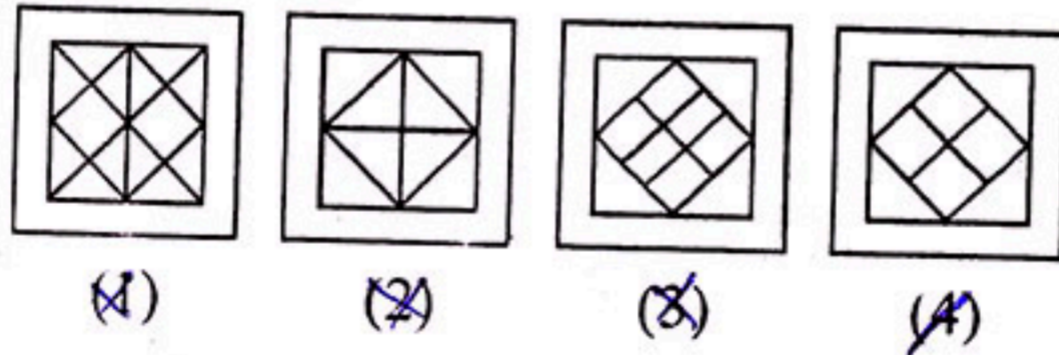
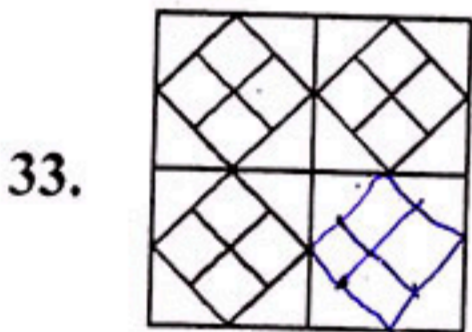
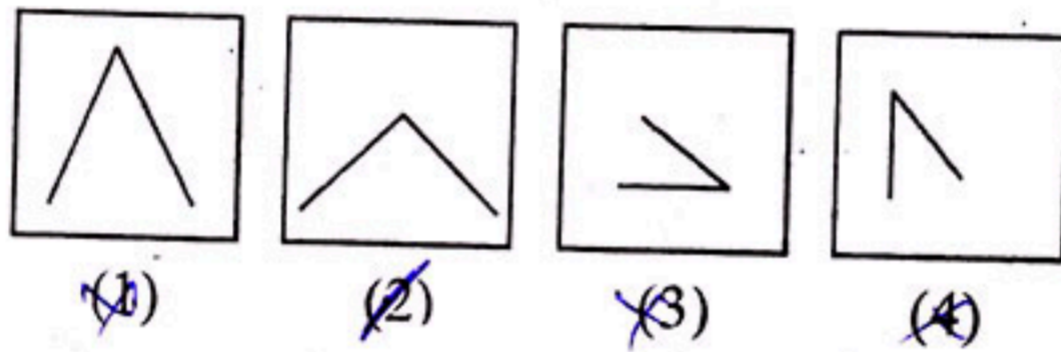
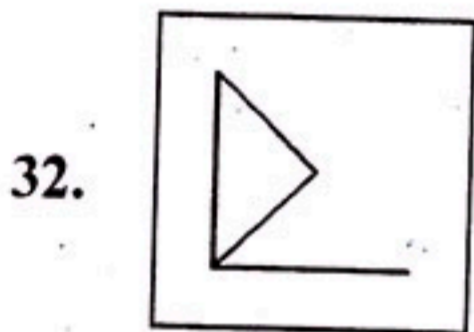
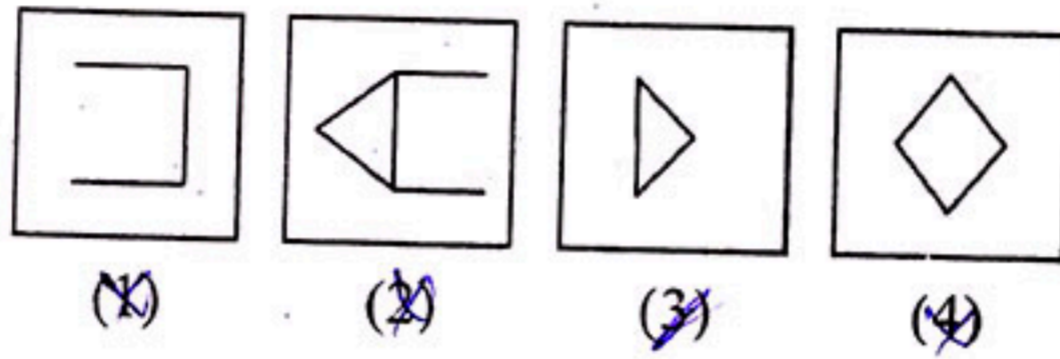
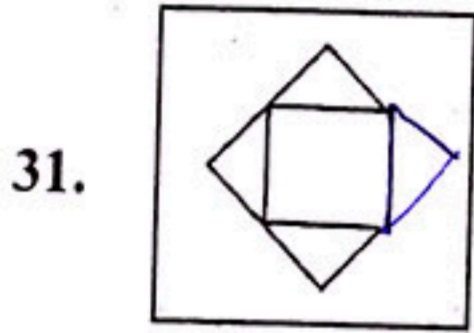

PART - VIII

Directions : In Question Nos. 36 to 40, there are three question figures on the left hand side and the space for the fourth figure is left blank. The question figures are in a series. Find out one figure from among the answer figures given on the right hand side which occupies the blank space for the fourth figure on the left hand side and completes the series. Indicate your answer by number of the answer figure chosen by you in the box against the number corresponding to the question.

Question Figures

Answer Figures

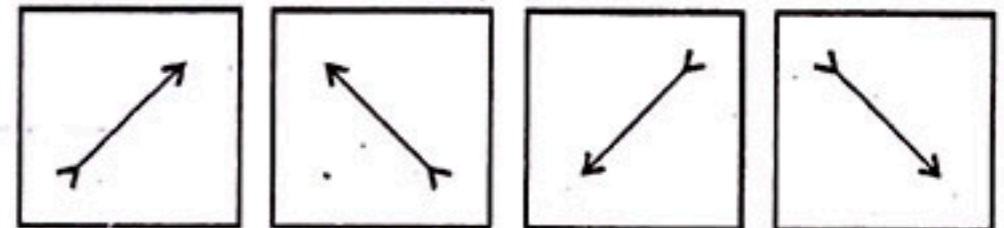
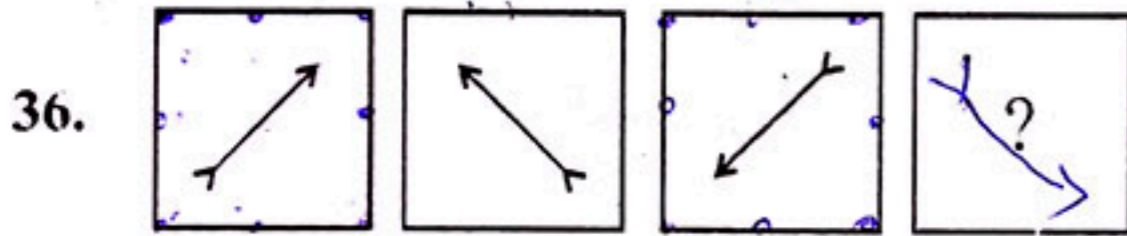

~~(1)~~ ~~(2)~~ ~~(3)~~ ~~(4)~~

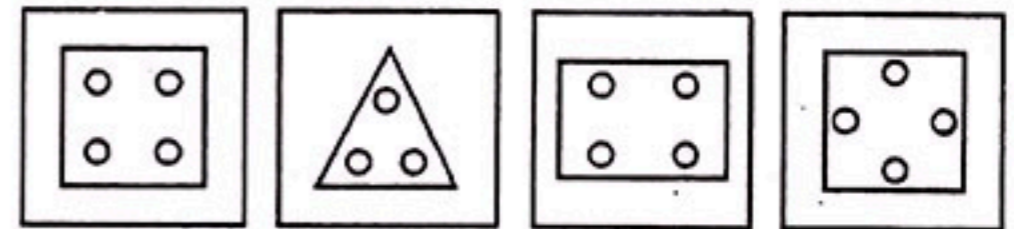
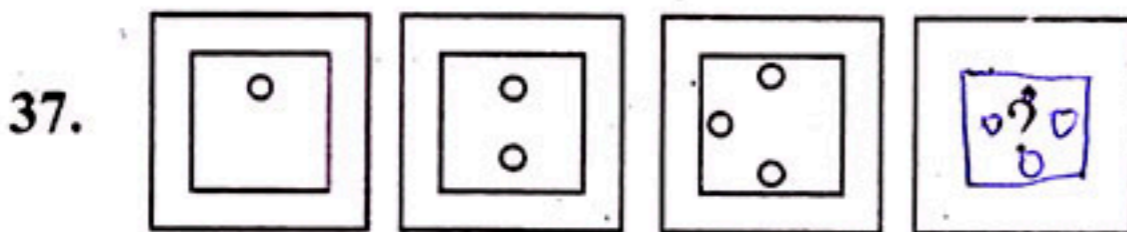

~~(1)~~ ~~(2)~~ ~~(3)~~ ~~(4)~~

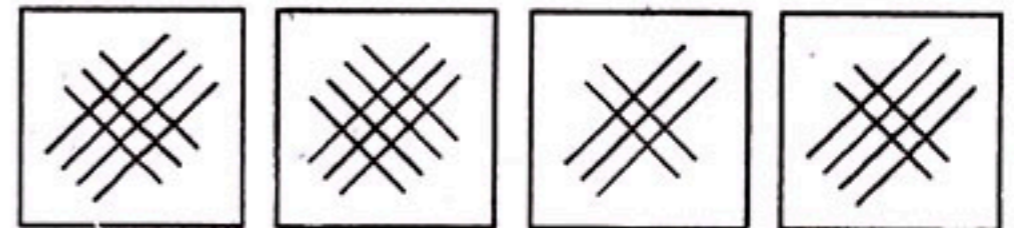
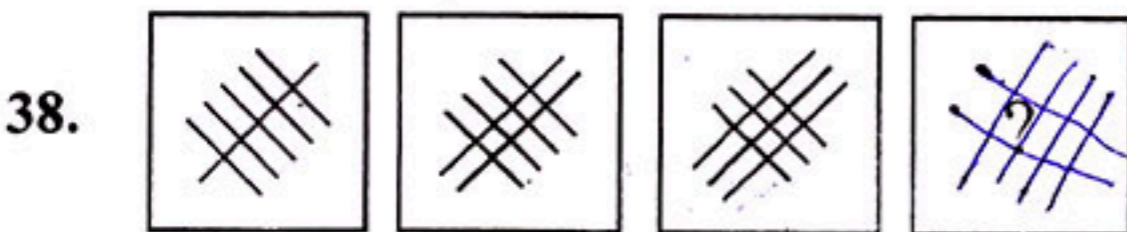

~~(1)~~ ~~(2)~~ ~~(3)~~ ~~(4)~~

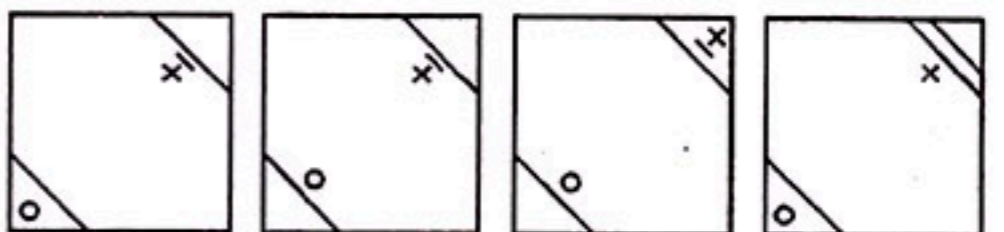
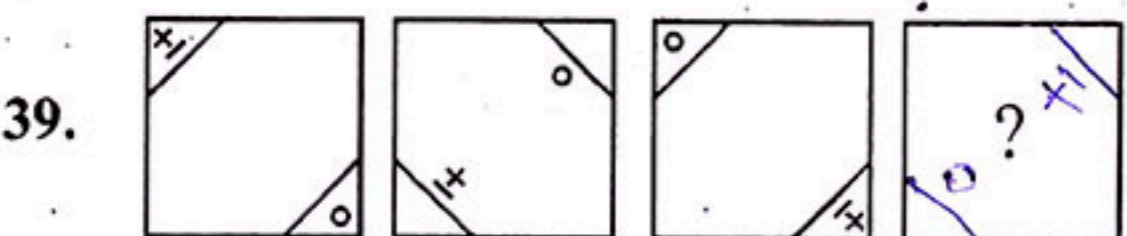

~~(1)~~ ~~(2)~~ ~~(3)~~ ~~(4)~~

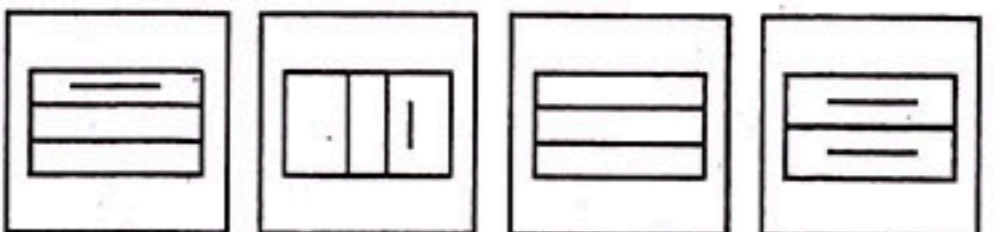
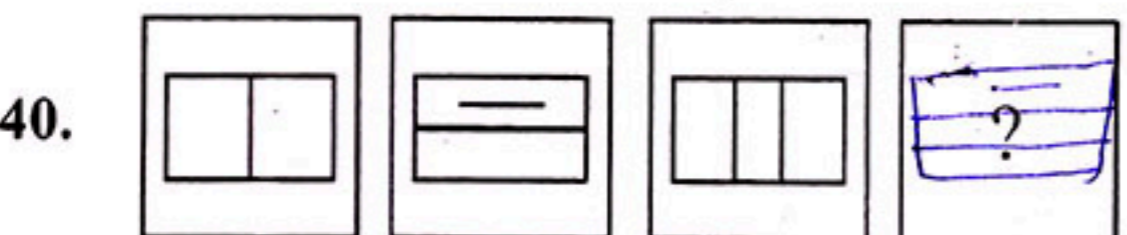

~~(1)~~ ~~(2)~~ ~~(3)~~ ~~(4)~~

PART - IX

Directions : In Question Nos. 41 to 45, there are two sets of two question figures each. The second set has an interrogation '?. There exists a relationship between the first two question figures. Similar relationship should exist between the third and fourth question figure. Select one of the answer figures which replaces the mark of interrogation. Write the number of the answer figure selected by you in the box against the number corresponding to the question.

Question Figures

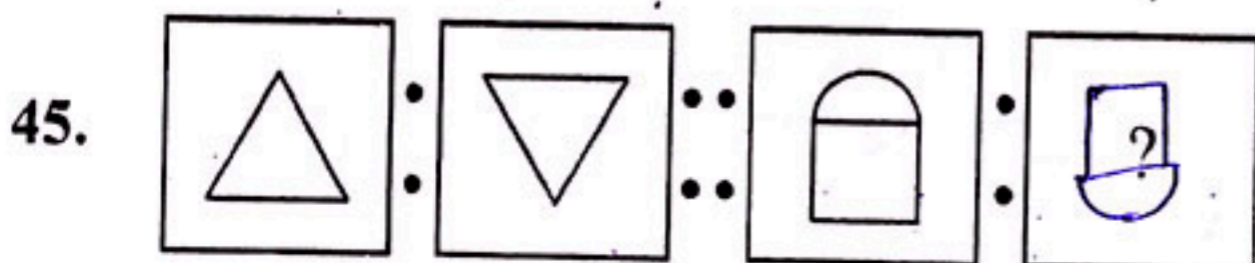
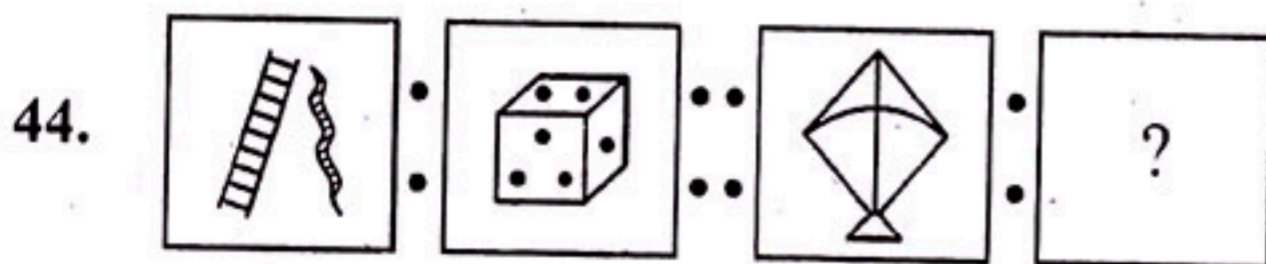
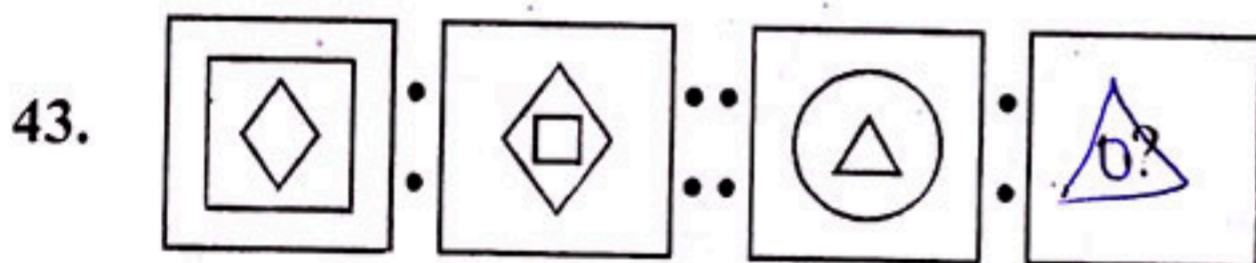
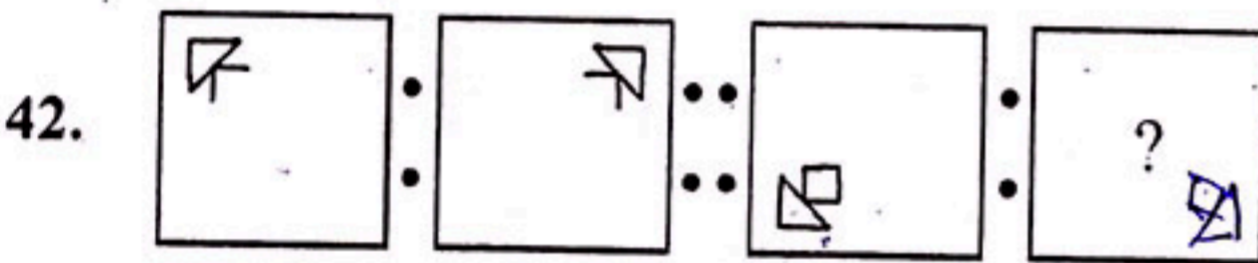
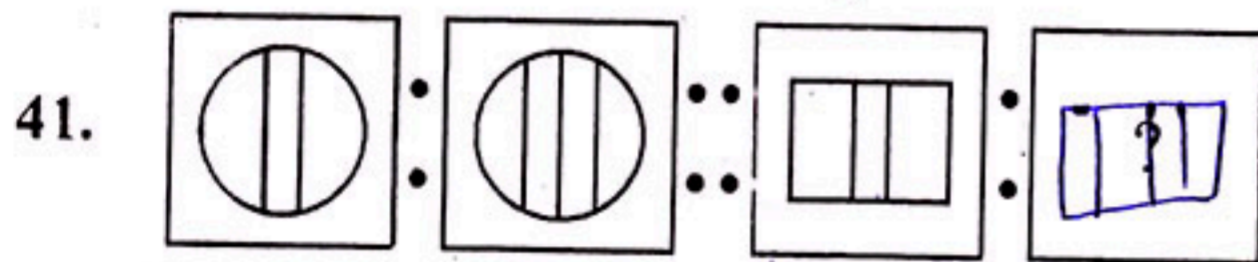

Answer Figures

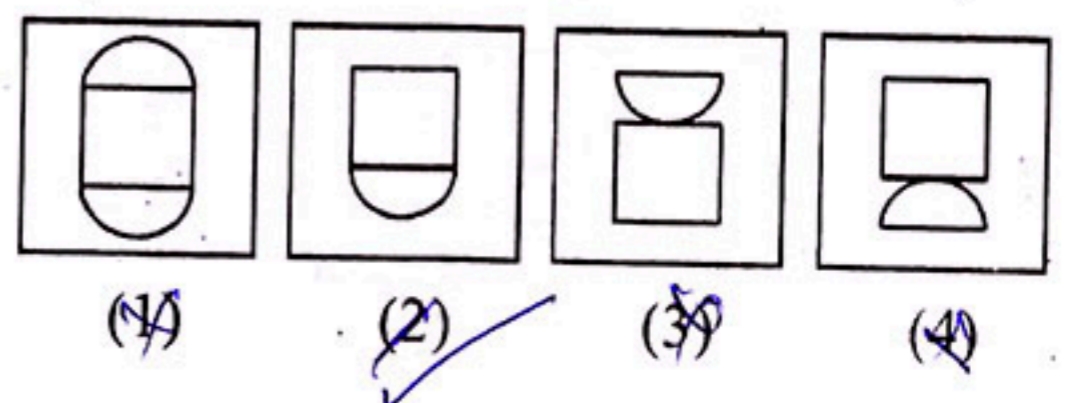
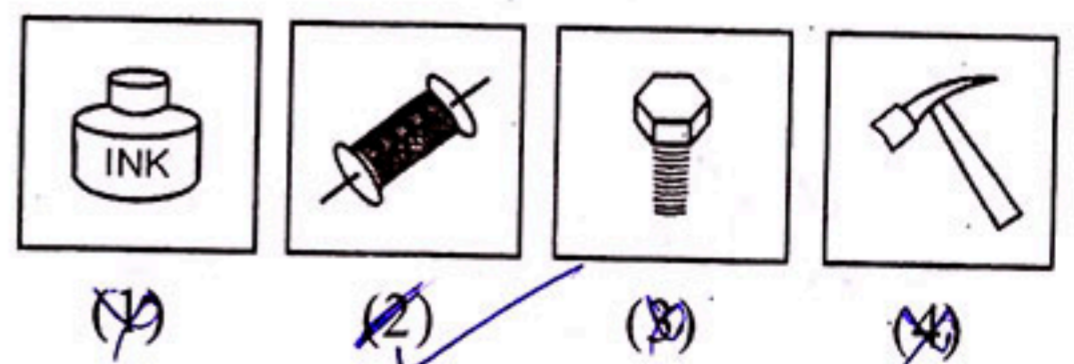
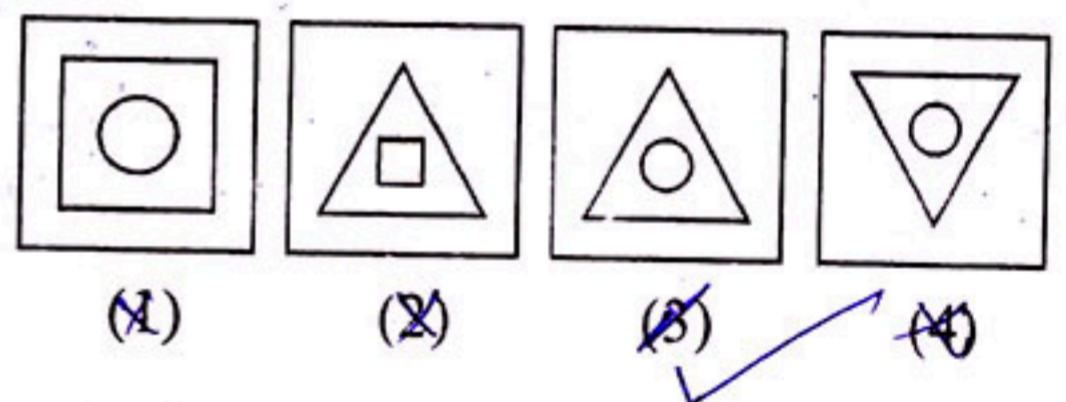
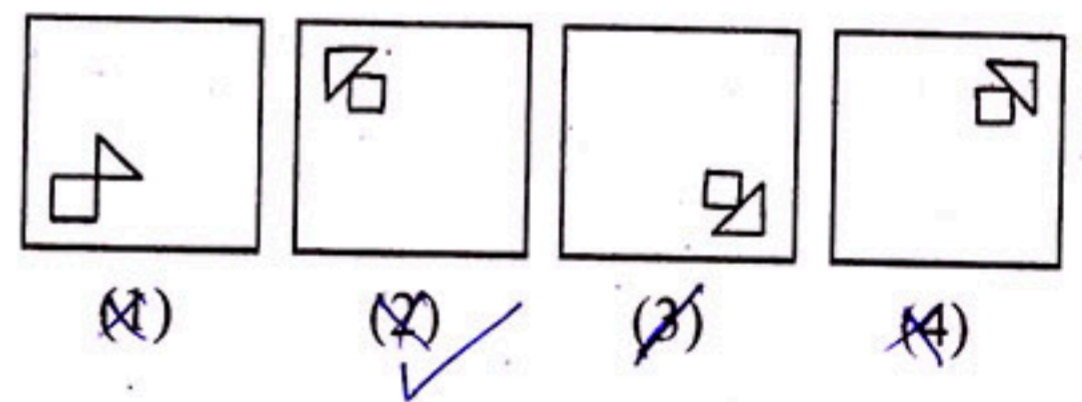
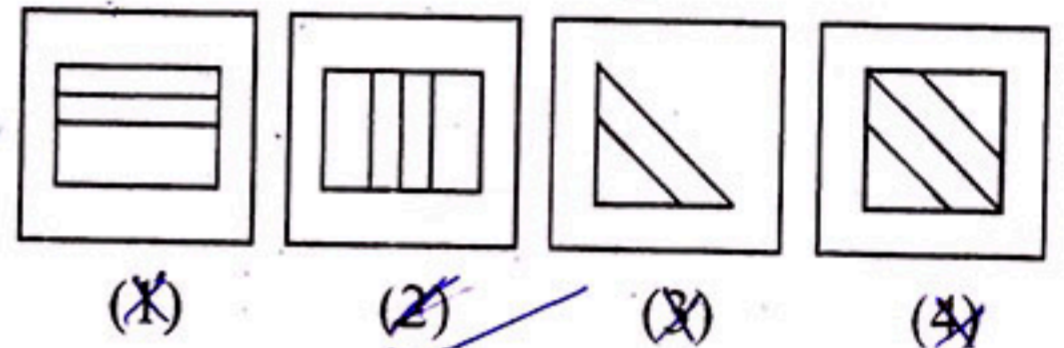

(11)
PART - X

Directions : In Question Nos. 46 to 50, one part of a geometrical figure (Triangle, Square, Circle) is on the left hand side as question figure and the other one is among the four answer figures 1, 2, 3, 4 on the right hand side. Find the figure on the right hand side that completes the geometrical figure and write the number given below that figure in the box against the number corresponding to the question.

	Question Figure	Answer Figures			
46.					
		(1)	(2)	(3)	(4)
47.					
		(1)	(2)	(3)	(4)
48.					
		(1)	(2)	(3)	(4)
49.					
		(1)	(2)	(3)	(4)
50.					
		(1)	(2)	(3)	(4)

SECTION – II
ARITHMETIC

Directions : For every question, **four** probable answers bearing numbers 1, 2, 3 and 4 are given. Only **one** out of these is **correct**. You have to give the correct answer and write the number in the box against the number corresponding to the questions in the answer-sheet.

- 51.** If a is the predecessor of b , then the value of $(a - b)$ and $(b - a)$ are
 (1) -1 and 1 (2) 1 and -1
 (3) 0 and 1 (4) 1 and 0
- 52.** Joseph scored 8 marks fewer than Amit in an examination. Kumar scored 12 marks more than Amit. In total, they scored 205 marks. What was the score of Joseph?
 (1) 67 (2) 79
 (3) 59 (4) 75
- 53.** Sharda bought a note book for ₹ 25.50, a pen for ₹ 7.50 and 6 pencils each costing ₹ 1.25. She gave a 50 rupee note to the shopkeeper. The amount returned by the shopkeeper is :
 (1) ₹ 9.50 (2) ₹ 15.75
 (3) ₹ 40.50 (4) ₹ 18.50
- 54.** The pictograph shows the number of baskets of mangoes sold by a trader in five days.
- | Monday | Tuesday | Wednesday | Thursday | Friday |
|--------|----------------|-----------|----------------|--------|
| ○○○○○ | ○○○○○
○○○○○ | ○○○○○ | ○○○○○
○○○○○ | ○○○○○ |
- (○ represent 20 baskets)
 If the trader still had 200 baskets left after 5 days, how many baskets did he have in the beginning?
 (1) 620 (2) 720
 (3) 820 (4) 931
- 55.** The product of H.C.F. and L.C.M. of two numbers is 384. If one of them is 24, then other number is :
 (1) 18 (2) 6
 (3) 32 (4) 16
- 56.** The sum of two numbers is 345678. If one number is sixteen thousand sixteen greater than the other number, what is the greatest number?
 (1) 164831 (2) 170847
 (3) 180847 (4) 329662
- 57.** Which of the following number is divisible by 18?
 (1) 444444 (2) 555555
 (3) 666660 (4) 666666
- 58.** 128 boxes are packed with 36 toffees in each box. If 4 toffees are packed less in a box, then the new number of boxes which can be filled with the same number of toffees is :
 (1) 108 (2) 144
 (3) 216 (4) 360
- 59.** What is the length of the longest tape which can be used to measure exactly 1 m 75 cm, 4 m 50 cm and 6 m 50 cm?
 (1) 25 cm (2) 50 cm
 (3) 55 cm (4) 75 cm

60. Amar borrowed ₹ 800 at a rate of interest of 5% per annum. The amount he will pay after $3\frac{1}{2}$ years is :

- (1) ₹ 920 ~~(2)~~ ₹ 940
(3) ₹ 960 (4) ₹ 980

61. When 48.480 is divided by 8, quotient obtained is

- ~~(1)~~ 6.060 (2) 60.60
(3) 6.006 (4) 6.60

62. If $4137 \div 1.75 = 2364$, then $41.37 \div 17.5$ is equal to

- (1) 0.2364 ~~(2)~~ 2.364
(3) 23.64 (4) 236.4

63. The decimal equivalent to $\frac{1}{10} + \frac{11}{100} + \frac{111}{1000}$ is

- (1) 11.11 (2) 0.123
~~(3)~~ 0.321 (4) 0.1111

64. Rahul purchased old TV for ₹ 3,000. He spends ₹ 300 on its repair. He sold TV for ₹ 3,500. What is his profit ?

- (1) ₹ 500 (2) ₹ 250
~~(3)~~ ₹ 200 (4) ₹ 300

65. The sum of first four multiples of 8 is

- (1) 60 (2) 70
~~(3)~~ 80 (4) 100

66. Observe the following pattern of triangles made of match-sticks :

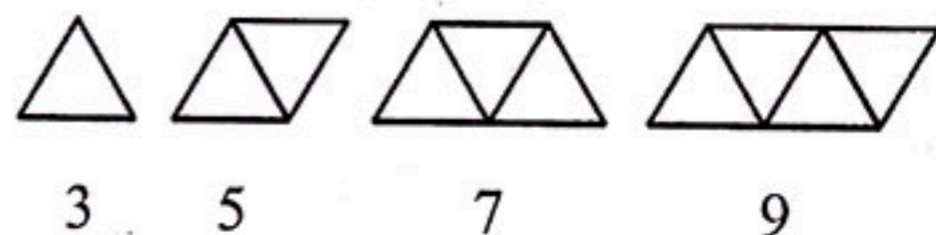

Number of triangles	1	2	3	4
Number of matchsticks	3	5	7	9

How many match-sticks do you think are required to make 10 triangles ?

- (1) 15 (2) 19
~~(3)~~ 21 (4) 25

67. The sum of the digits of a number is subtracted from the number. The resulting number is always divisible by

- (1) 2 (2) 5
(3) 8 ~~(4)~~ 9

68. Jammu express starts from Jammu at 8:20 AM. It takes 8 hours 35 minutes to reach Delhi. If it is late by 25 minutes then at what time will it reach Delhi ?

- (1) 5:15 PM (2) 4:55 PM
 (3) 5:20 PM (4) 4:40 PM

69. The area of adjacent figure is

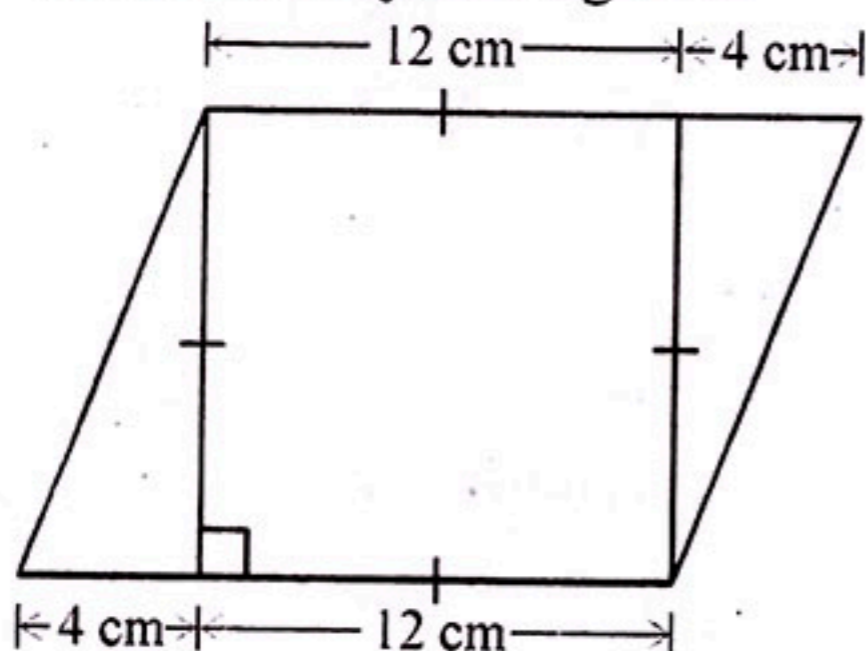

- (1) 144 cm^2 (2) 168 cm^2
 (3) 192 cm^2 (4) 236 cm^2

70. A train starts at 1:45 PM from a station at a speed of 60 km/hr. At what time will it reach a station 165 km away ?

- (1) 3.45 PM (2) 4.15 PM
 (3) 4.30 PM (4) 6.00 PM

71. What should be side of square (in cm.) if its perimeter is equal to area ?

- (1) 6 cm (2) 2 cm
 (3) 4 cm (4) 8 cm

(14)

72. A fruit shop sells bananas at ₹ 40 per dozen or a banana for ₹ 5. How much will it cost to buy 99 bananas ?

- (1) ₹ 335 (2) ₹ 320
 (3) ₹ 300 (4) ₹ 495

73. 12 men or 15 women can finish a work in 24 days. In how many days the same work can be finished by 8 men and 8 women ?

- (1) 16 days (2) 20 days
 (3) 24 days (4) 28 days

74. The incomplete bar graph shows Samyukta's savings during the first five months of a particular year. She saved a total of ₹ 950 during five months. The amount of money saved in February was as much as that saved in March. How much did she save in February ?

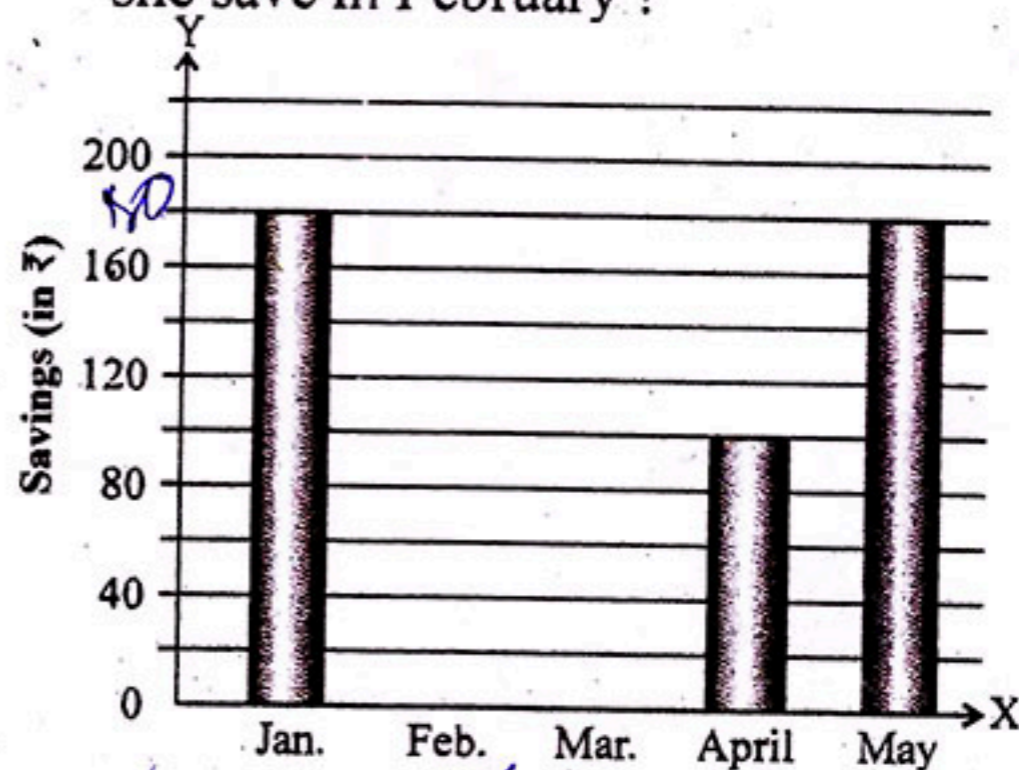

- (1) ₹ 245 (2) ₹ 275
 (3) ₹ 250 (4) ₹ 225

75. A fish tank can hold 45 litres of water when filled to the brim. It is $\frac{4}{9}$ filled, if $\frac{2}{5}$ of the water is removed, how much more water must be added in order to fill the tank to the brim ?

- (1) 12 litres (2) 20 litres
 (3) 33 litres (4) 35 litres

SECTION – III LANGUAGE

Directions : There are five passages in this Section. Each passage is followed by five questions. Read each passage carefully and answer the questions that follow. For each question four probable answers bearing numbers 1, 2, 3 and 4 are given. Only **one** out of these is **correct**. You have to choose the correct answer and write the number in the box against the number corresponding to the question in answer sheet.

Passage – I

Long ago our rivers were fresh and clean ; so clean that people drank the river water. Those rivers were full of fish. People caught and cooked them. In time people built factories and towns that used the river water. Boats are used to carry goods and coal and oil, which sometimes falls into the water. People throw their garbage and dirty water into the rivers. They say, "Our garbage cannot make much difference".

But now the rivers have become too dirty to drink from and the fish have died. The rivers are now full of garbage that floats on the water.

- 76.) What happened first ?
- (1) Fish were gone from the rivers.
- (2) Factory boats came down the rivers.
- (3) The rivers were clean and beautiful.
- (4) Towns built more and more factories.
77. The word opposite in meaning to the word 'clean' is _____.
- (1) dirty (2) nice
- (3) rich (4) different
78. Why did the rivers get dirty ?
- (1) Factories have been built in the towns.
- (2) Fish died in the rivers.
- (3) Boats are used to cross the rivers.
- (4) People threw garbage into the river.
79. People ate fish from the rivers because _____
- (1) they could catch them from the boats.
- (2) the factories helped the people.
- (3) the fish were dying in the river.
- (4) the fish are found in the clean water of the rivers.
80. Which is the correct statement ?
- (1) The rivers were dirty from the beginning.
- (2) The people could not drink river water earlier.
- (3) The rivers became dirty because of the oil and garbage thrown in.
- (4) There were no fish in the rivers because people cooked and ate them all.

Passage – II

A robot is a machine. It is a machine that moves. It follows instructions. The instructions come from a computer. Because it is a machine, it does not make mistakes. It does not get tired. And it never complains.

Some robots are used to make things. Robots can help making cars. Some robots are used to explore dangerous places like exploring volcanoes. Some robots are used to clean things. These robots can help clean your house. Some robots can even recognize words. They can be used to help answer telephone calls. Some robots look like humans. But most robots just look like machines.

The first robot was built by George Devol in 1954 and was named Unimate. It was used to make cars. In the future, we will have even more robots that can fight fires, fight wars and fight sickness. They will help make life better.

81. Find a word from the passage which means 'discover'.

- (1) explore
- (2) recognize
- (3) instruct
- (4) complain

82. The word opposite in meaning to the word 'dangerous' is :

- (1) free
- (2) beautiful
- (3) ugly
- (4) safe

83. When was the 1st robot made ?

- (1) 1954
- (2) 1900
- (3) 2003
- (4) 2000

84. What was the name of the first real robot ?

- (1) Giant arm
- (2) Unimate
- (3) Robot
- (4) Special

85. The first robot was used to :

- (1) answer telephone calls
- (2) explore volcanoes
- (3) clean things
- (4) make cars

Passage – III

I stood in the bathroom as Mama scrubbed me with soap. It was as if she was waging a war against germs. Mama wanted me to be very clean so that I would not dirty the clean sheets that she had washed, by rubbing them on a stone. Once my bath was over, I lay alone on my bed. I talked to my pillow, then to an imaginary friend, and finally to the dragon under my bed, who was actually very friendly. My mother was obsessed with cleanliness and she did not allow even the smallest bit of dirt to remain in the house. Her fight against dirt was equal to her passion for cooking. Our house always smelt of food that she cooked with great care and of her baking. Her cakes, biscuits, and cupcakes were the talk of our neighbourhood. I was very fond of her cakes and chocolate cookies that melted in my mouth. She was very generous and our neighbours always received a batch of freshly baked biscuits.

86. The word 'obsessed' means to :
- (1) be angry all the time.
 - (2) be constantly worrying.
 - (3) hate everybody.
 - (4) like everybody.
87. How do we know that the mother liked cooking ?
- (1) Her house always smelt of food.
 - (2) She cooked regular meals.
 - (3) She kept her house clean.
 - (4) She gave generously to the neighbours.
88. Mama wanted the child to be very clean, because :
- (1) she was always dirty.
 - (2) she did not want her to dirty her sheets.
 - (3) she wanted her to sleep well.
 - (4) she wanted her to go clean to the school.
89. What would the child not do after her bath ?
- (1) talk to an imaginary friend
 - (2) talk to her mother
 - (3) talk to the pillow
 - (4) talk to a dragon
90. What did the neighbours talk about ?
- (1) mother's cleanliness
 - (2) the child's cleanliness
 - (3) mother's baking
 - (4) child's imagination

Passage – IV

Market day in a village is enjoyed by children and women and men. It is a good place for farmers to sell their vegetables and grain and all the things they grow in their fields. Early in the morning, the farmers load their bullock carts and tractors with sacks full of grain and baskets full of fruits and vegetables. They also carry their sheep and goats, cows and buffaloes and chickens that they want to sell at the market. They need to buy things also at the market. They need clothes and spices, and also several household goods. These things are not easily available near their farms.

The women buy colourful glass bangles from the bangle sellers. Fires are lit. Pakoras, puris and sabzi are cooked. Samosas and sugarcane juice are also very popular. Children run around happily with their friends. They take rides on swings and merry-go-rounds. Everyone loves a market day.

91. Which of the following words means the same as the word, 'sacks' ?
- (1) boxes (2) bags
(3) cartons (4) packets
92. What do the children do at the market ?
- (1) sell vegetables and grain
(2) buy chickens and goats
(3) play around with their friends
(4) sell pakoras and samosas
93. Why is the market day in the village a good day for farmers ?
- (1) Farmers meet their friends in the market.
(2) It is a good place to sell the things farmers grow
(3) The farmers have a lot of fun at the market.
(4) The farmers get a chance to sit and eat samosas.
94. How do the farmers carry their vegetables and grains to the market ?
- (1) in their trucks and cars
(2) in their bullock carts and tractors
(3) The farmers themselves carry them on their heads.
(4) They are carried by helpers and friends.
95. What else do the farmers carry to the market ?
- (1) their cattle and chickens
(2) furniture
(3) clothes
(4) toys

(19)
Passage – V

In April, just two weeks before the examinations, Swami realized that his father was changing – for the worse. He was becoming fussy and difficult. When Swami was seen chatting with his granny, he was told, “Remember boy, there is an examination. Your granny can wait, not your examination.” If he was seen moving behind his mother, he was caught and sent to his desk. If his voice was heard anywhere after the Taluk Office gong had struck nine, a command would come from his father’s room, “Swami, why haven’t you gone to bed yet ? You must get up early and study a bit.” One day, he asked his father, “Why are you so nervous about my examinations ?”

96. The word ‘command’ in the passage means :

- (1) to respect
- (2) to punish
- (3) to catch
- (4) to order

97. When the Taluk Office gong struck nine, Swami had to

- (1) study
- (2) get up from bed
- (3) go to bed
- (4) go to school

98. When did Swami realize that his father was changing ?

- (1) in April
- (2) in May
- (3) in June
- (4) in July

99. What had his father become ?

- (1) happy and simple
- (2) sad and angry
- (3) angry and fussy
- (4) fussy and difficult

100. Where was Swami sent to, when he was seen walking behind his mother ?

- (1) to the kitchen
- (2) to his desk
- (3) to his father’s room
- (4) to the bedroom